

**TrinaTracker**

Boosting power beyond the horizon

Leading the way  
in smart PV and energy storage solutions



**Trina**solar



\*TrinaTracker reserve all the right for the final explanation

URL:<https://www.trinasolar.com/cn/trinatracker>

# TrinaTracker Smart Solution

- highly reliable tracker - smart software platform - professional local service



# Boosting power beyond the horizon

## 01

### Company Profile 03

- About us 03
- Development History 05
- Globalization 07
- Development History 09
- Manufacturing Leadership 11

## 02

### TrinaTracker Smart Solution 13

- Vanguard-1P 15
- Vanguard-2P 17
- FixOrigin 19
- Trina Smart Cloud 21
- Smart Tracking Algorithm(STA&SBA) 22
- Completed Service 23

## 03

### Case Study 25



# About us

At TrinaTracker, a business unit of Trinasolar, we specialize in smart mounting systems with a presence on all five continents. Currently, we have accumulated over **20+GW** across more than **700+ projects** worldwide. At TrinaTracker, we offer a comprehensive solution that combines innovation, quality, and technology with the ability to adapt to any scenario and meet the needs of our clients. We are motivated to work towards a more sustainable and just world, where the production of clean energy is not a future goal but our current practice.

# 01

## Company Profile



### Strong R&D and Engineering Team

Innovation hubs in China and Spain  
Teams experts  
Partnership with world-leading consultants



### Reliable & Smart Tracking Solution

Vanguard 1P /Vanguard 2P  
Smart Control System ( SuperTrack  
+ Trina Smart Cloud+Smart Controllers)



### Our leading indicators

**10+GW** production capacity  
**20 years** of industrial experience  
**60** countries across 5 continents



### Life-cycle Service

Pre-sales engineering, in-sales engineering  
In-sales delivery and installation guidance  
After-sales O&M services



# Development History

1961



- In 1961, Nclave's parent company, Grupo Clavijo, was established as one of the world's first companies to develop and produce PV structures.

1997



- In 1997, Inspired by the "Kyoto Protocol" and the "Million Solar Roofs Initiative of the United States", Trina Solar was founded.

2008



-In 2008, Trinasolar, leading upstream and downstream company, built China's first industrial park named after a company – "Trina PV Industrial Park", which was one of the largest comprehensive industrial parks featuring PV in the world at the time.

2018



- In 2018, Trina solar became the holding company of Nclave through equity acquisition and launched the "TrinaPro" solution in the same year.

2020



- In 2020, Trinasolar issued first A-Shares on Shanghai Sci-Tech Innovation Board, known as STAR Market, becoming the first Chinese PV product, PV system and smart energy company to trade on the STAR Market. Trina Solar acquired Nclave 100% and launched the "TrinaTracker" brand. Trina Solar launched "Vanguard" multi-drive 2P trackers and was awarded the world's first IEC62817 certification. The first corporate research institute specialized in "smart solar tracking systems" in Changzhou was established. Trina Solar was awarded the Qualified Test Lab (QTL) certification from Germanybased SGS.

2022



- New Vanguard 1P Launch,  
- TrinaTracker Intelligent System Upgrade,  
- Smart Control System Solution Launch.

2023



By the end of 2023, TrinaTracker has delivered more than **20GW** mounting structure system. TrinaTracker had launched the new generation of Vanguard 2P with multi-motor systems worldwide in online format.

2024



- New Upgraded version Vanguard 1P



- New version of Trina Smart Cloud



# Globalization

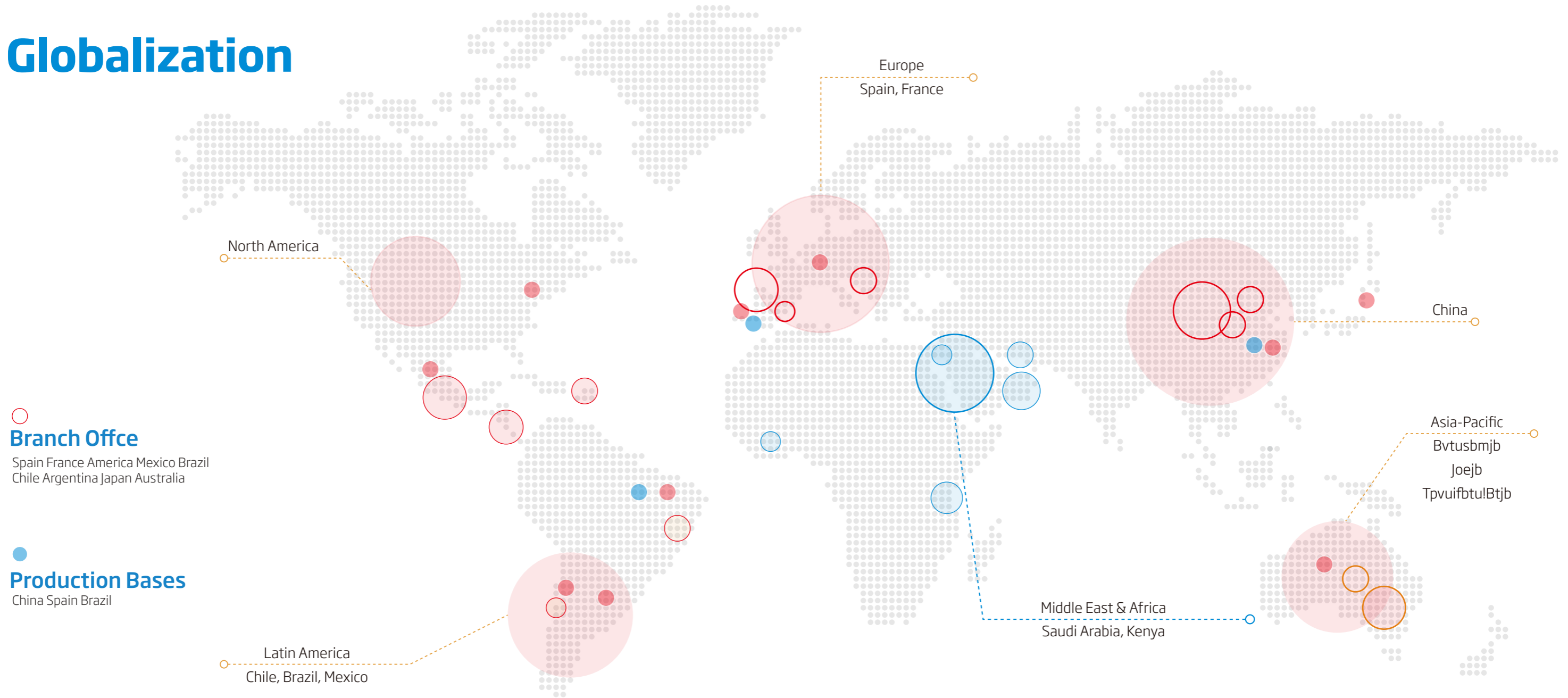

**20** years  
Experience



**20GW+**  
Global Volume



**60**  
Dierent Countries



**10GW**  
In-house capacity



# Development History

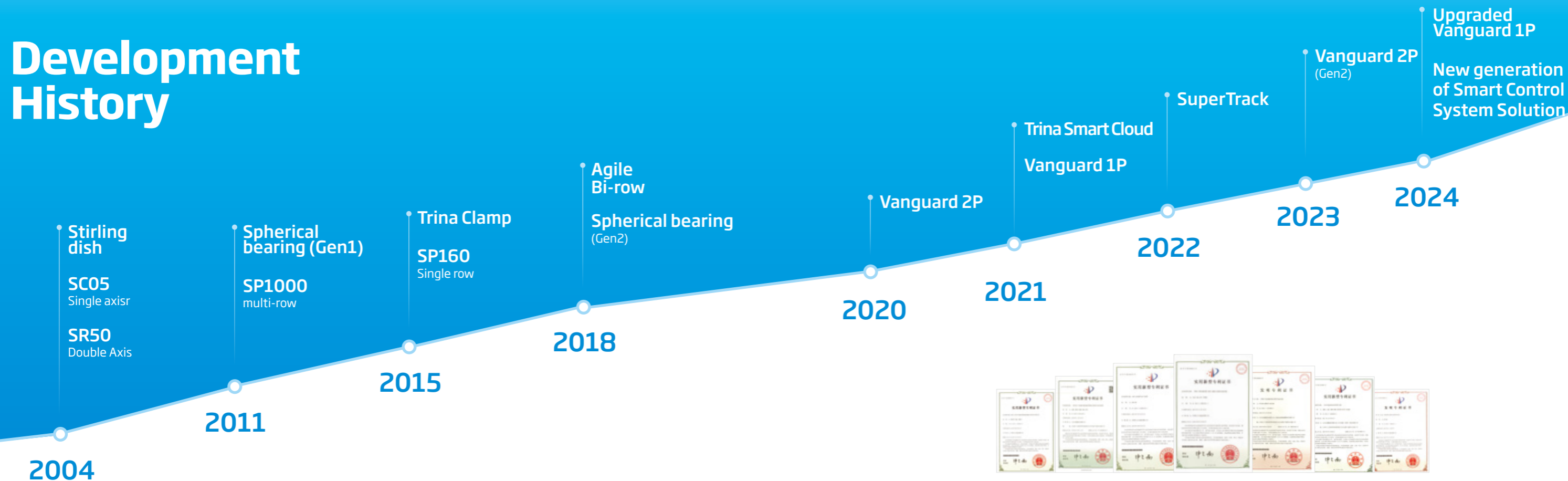

### Global Exclusive Patented Spherical Bearing

**Multiple mounting holes**  
Easy to install  
Adjust construction error

**Polymer material**  
UV resistance, corrosion resistance, self-lubricating system  
Reduce operation and maintenance costs

**High stability**  
Equipped with patented spherical bearings with angle adjustability up to 30%

# 30%

### Patented Module Mounting Component: Trina Clamp

**-50%**  
Innovative Trina Clamp installation  
Save 50% installation time

## Patented Technologies

- Trackers for PV modules suitable for sites prone to foundation settlement
- An adjustable PV tracker for complex terrains
- An optimal method for tilt angles for tracking of bifacial PV modules
- A non-interfering household wireless communication system and its networking method
- A method for calculating the mismatch loss on the rear side of bifacial PV modules Etc.

patents application  
**205**  
patents for invention  
**86**

## Utility Model Patents

- A mounting structure for installing dual-glass modules on the solar tracker
- An adjustable PV tracker for mountainous areas
- An intelligent PV module with IV curve scanning function and its power generation system
- A tracking system for PV trackers Etc.

utility model patents  
**88**

## Product Standards

- SGS Qualified Witness Test Lab certification  
IEC/EN 62109-1: 2010 IEC/EN 62477-1: 2011+A1: 2016 UL3703
- TÜV SÜD Qualified Witness Test Lab certification  
IEC/EN 62817: 2014/AMD1: 2017





# Manufacturing Leadership

The smart solar tracker factory featuring innovation, reliability and intelligence demonstrates the industry advantages of TrinaTracker. By leveraging advanced manufacturing equipment, the Production + Research platform, and the life cycle quality management concept, TrinaTracker actively creates industry-leading tracker products.

TrinaTracker will further fully integrate and utilize hardware and software to realize intelligent manufacturing scenarios integrating intelligent production, coordinated decision-making, intelligent IoT, planning collaboration, and quality control. Meanwhile, it will use intelligent approaches to define product paths and business scenarios, identify customer needs and product configurations, and continue to optimize the use of sites while allowing for restrictions to continuously improve value and energy yield for clients and achieve win-win cooperation.





# 02

## TrinaTracker Smart Solution



Vanguard 1P

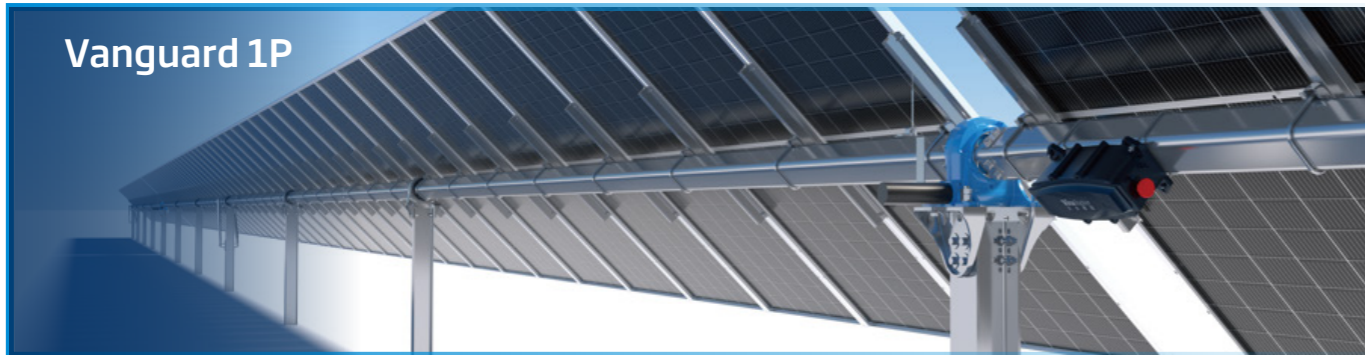

Vanguard 2P



### Trina Smart Cloud

- Intelligent and accurate O&M
- Precise and intelligent control
- Reduce power generation loss
- System security and stability
- Digital map positioning



### Smart Tracking Algorithm(STA&SBA)

- Boost energy yield under cloudy, overcast and other highly diffused irradiation conditions
- Reduce the loss of energy yield caused by shading in complex terrains
- Increase energy yield by as much as 8% compared with conventional tracker control system





# Vanguard 1P



## Single row - 1 in portrait - single-axis tracker

- 1 in portrait, ultra compatible with 700W+ module
- Optimized terrain adaptability: 15% N/S E/W
- Tracking range:  $\pm 60^\circ$
- Cleaning robot solution for easier O&M
- Quick installation design, reduce the installation costs by up to 19%
- Flexible wind protection strategies
- Innovative snow & hail protection

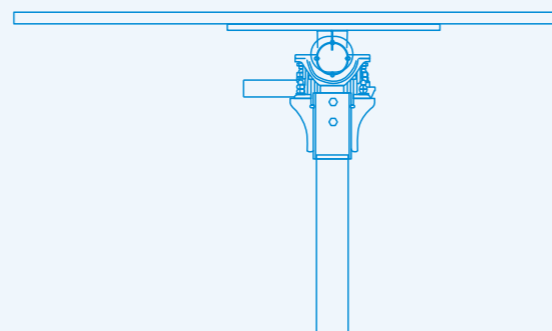

### GENERAL FEATURES

Solar tracker type	Single row, single axis
Tracking range	$\pm 60^\circ$ (120°)
Driver	Multi-slewing drive
Configuration	1 module in portrait (1P) 3-4 string big format module (1500V string) <sup>(1)</sup>
Solar module supported	Framed
Foundation options	Direct ramming / Pre-drilling + ramming / Micropile / PHC piles
Pile section	W type, C type
Modules attachment	Bolts, Rivets
Piles per MW	~239 piles/MW (4-string module)
Terrain adaptability	20% W-E, 15% N-S <sup>(2)</sup>
Wind and snow loads tolerance	Tailored to site requirement
GCR	$\geq 25\%$
Design wind speed	55m/s <sup>(3)</sup>

### STRUCTURE

Material	High yield strength steel
Coating	HDG, pre-galvanized & ZM <sup>(4)</sup>

### CONTROLLER

Controller	Electronic board with microprocessor
Ingress protection marking	IP65
Tracking method	SuperTrack Smart Tracking Algorithm <sup>(5)</sup> / Conventional Tracking Algorithm
Advanced wind control	Customizable
Anemometer	Cup / Ultrasonic
Night-time stow	Configurable
Communication with the tracker	Wireless option: LoRa / Zigbee
Operating conditions	Altitude < 4000m <sup>(2)</sup> Temperature: 30~60°C <sup>(2)</sup>
Sensors	Digital inclinometer
Motor power	DC: 0.15kW
Power supplier	String-powered / Self-powered / AC-powered

\*1 TrinaTracker adapts to various types of modules.

\*2 For scenarios that are out of scope, consult TrinaTracker.

\*3 The wind speed is based on ASCE 7-16. If the wind speed is out of scope, please consult TrinaTracker.

\*4 This is standard configuration and the coating can be customized according to needs.

\*5 Includes smart tracking algorithm and smart backtracking algorithm.

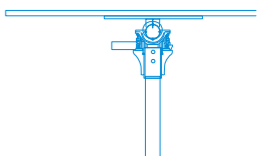



# Vanguard 2P



## Single row - 2 in portrait - single-axis tracker

- 2 in portrait, specially designed for ultra-high-power modules up to 700W+ with electrification control system for greater stability.
- Up to 120 modules per tracker
- Optimized terrain adaptability up to 15% N/S
- Tracking range  $\pm 60^\circ$
- Less pile design for lower BOS in difficult scenarios of piling.
- Best for challenging sites such as irregular layout, undulated terrain, and high wind regions
- Independent row design for easier accessibility of O&M vehicles

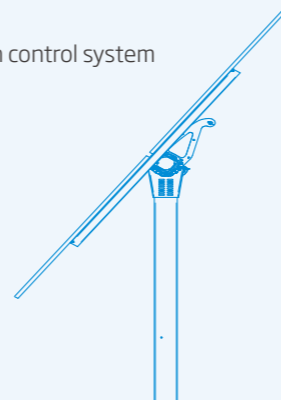

### GENERAL FEATURES

Solar tracker type	Single row, single axis
Tracking range	60° (120°)
Driver	Multi-slewing drive
Configuration	Two module in portrait (2P) Up to 4 strings per tracker (1500V string)
Solar module supported	Framed
Foundation options	Direct ramming / Pre-drilling + ramming / Micropile / PHC piles
Pile section	W, compatible with IPE, IPEA
Modules attachment	Bolts, Rivets
Piles per MW	~125 piles/MW (4 string module)
Terrain adaptability	15% W-E, 15 % N-S <sup>(1)</sup>
Wind and snow loads tolerance	Tailored-to-site requirement
GCR	$\geq 25\%$
Design wind speed	45 m / s (This value depends on project conditions)

### STRUCTURE

Material	High Yield Strength Steel
Coating	HDG, Pre-galvanized & ZM <sup>(2)</sup>

### CONTROLLER

Controller	Electronic board with microprocessor
Ingress protection marking	IP65
Tracking method	SuperTrack Smart Tracking Algorithm <sup>(3)</sup> / Conventional Tracking Algorithm
Advanced wind control	Customizable
Anemometer	Cup / Ultrasonic
Night-time stow	Configurable
Communication with the tracker	Wireless option: LoRa / Zigbee
Operating conditions	Altitude < 4000m <sup>(4)</sup> Temperature: 30~60°C <sup>(4)</sup>
Sensors	Digital inclinometer
Power consumption	0.2kW·h/Day
Power supplier	String-powered / Self-powered / AC-powered

\*1 N-S: max 15%, for slopes higher than 10% consult with TrinaTracker.  
E-W: for slopes higher than 10%, consult with TrinaTracker.

\*2 Standard configuration. Other coating by request.

\*3 Includes smart tracking algorithm and smart backtracking algorithm.

\*4 Standard configuration. Different conditions under request, please consult TrinaTracker.

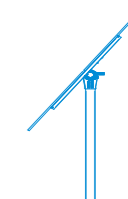

# FixOrigin™



## GENERAL FEATURES

<b>Structure design</b>	Monopost and Bipost fixed tilt structure
<b>Configuration</b>	Monopost 2P and 4L Bipost 2P, 3P, 4L and 6L
<b>Ground clearance</b>	Up to 1200mm (1)
<b>Inclination</b>	Up to 30°
<b>Terrain adaptability</b>	20% E-W, 30% N-S (2)
<b>Structure material</b>	S350-S420 GD or higher
<b>Coating</b>	HDG, Galvanised & ZM (3)
<b>Module fixation</b>	Clamps, bolts
<b>Inverter support</b>	Optional
<b>Ramming options</b>	Direct ramming Pre-drilling Micropile Concrete footing
<b>Warranty</b>	10 years: structure 5 years: commercial components

## FixOrigin™ Fixed Tilt Solution

- Compatible with modules up to 670W+
- Stability verified
- Easy assembly and O&M
- Foundation compatibility
- Minimum shades with bifacial modules
- Top quality materials

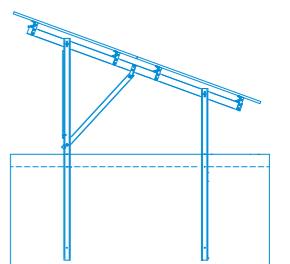
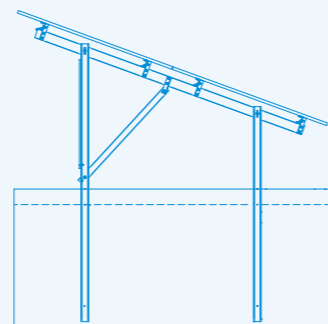

\*1 Standard up to 800mm. For higher loads contact TrinaTracker.

\*2 Standard conditions up to 10%. For higher slopes contact TrinaTracker.

\*3 Standard configuration. Other coating on request.



Trina Smart Cloud monitoring platform: integration of functions such as real-time monitoring, fault alarm, precision control, meteorological data sharing, log data recording, and data forwarding, empowering the plant cost reduction and efficiency increase.



**Smart O&M**

**Improve power generation efficiency**

**Reduce LCOE**



- 1 Monitoring & recording & forwarding**
  - Dynamically monitor the operating status of trackers
  - Store key information of trackers
  - Transfer the data to the power station monitoring platform
- 2 Meteorological data sharing**
  - Share meteorological data such as wind speed and irradiance
  - Reduce the number of sensors
  - Reduce power generation loss caused by sensor operation and maintenance
- 3 Multi-level system protection**
  - Multiple system safeguards ensure that running data would not be lost
- 4 Safety guarantee**
  - Access multi-role permission management
  - Log management enables historical traceability
  - Grant diversified operation permission
  - Hierarchical precision management

- Intelligent and accurate operation and maintenance**
  - Dynamically monitor the operating status of trackers
  - Real-time fault alarms
  - Key parameter analysis
  - Motor diagnostic and pre-warning
- Precise and intelligent control**
  - Running data query
  - Control trackers operation mode & target angle
  - Set trackers parameters individually & in groups
- Reduce power generation loss**
  - Share meteorological data between NCUs
  - Reduce power generation loss caused by sensor fault and O&M
- Digital map positioning**
  - Precisely locate the position & status of each tracker
  - Status display & positioning of key components of trackers
  - 3D digital modeling dynamic display of trackers layout and status
- System security and stability**
  - Multi-role permission management
  - Network security
  - Hardware & software security and stability

# Smart Tracking Algorithm(STA&SBA)



TrinaTracker has developed the smart tracking technology - SuperTrack, which includes smart algorithms(STA&SBA), multi-source data and a patents model.

SuperTrack can calculate the optimal power generation angle of the bifacial module in real time for different weather conditions, and identify the characteristics of the complex terrain in an intelligent way, independently optimize the angle of backtracking in each row, avoid row-to-row shading, and fully optimize the power generation potential of tracker. Compared with conventional tracking algorithm, boosting energy generation by as much as **8%**.

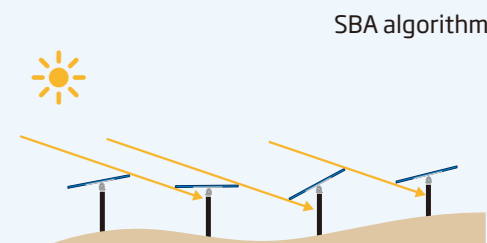
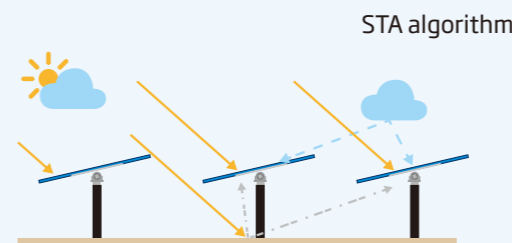
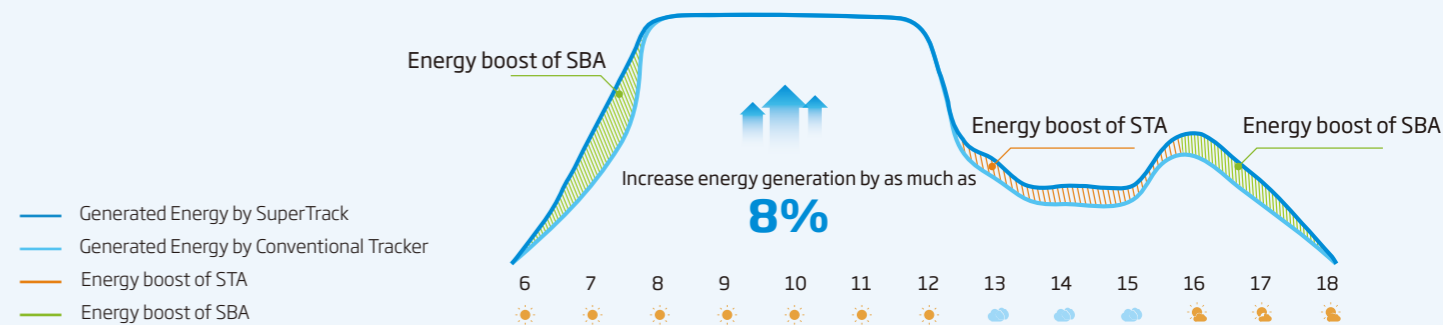
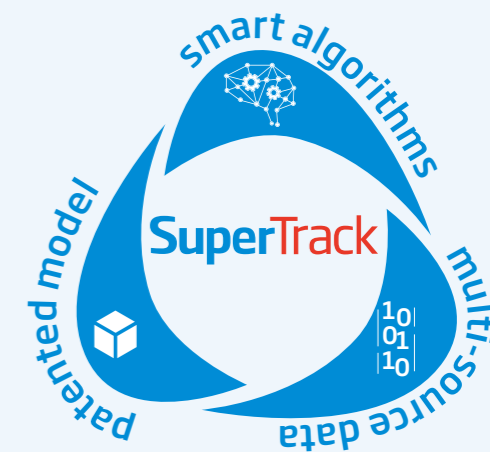

# Completed Service



## Pre-sales

### Pre-sales design/pull-out test

- Guidance on the design and implementation of pull-out tests
- Final design of pile foundation We assume the risks for pile foundation design with assurance
- International geological survey consultants
- Installation feasibility assessment

## Project Management

### On-site installation management & services (optional)

- Installation process and instruction manual preparation
- On-site installation training
- Subcontractor certification
- Schedule optimization and risk management
- On-site material management
- Installation guidance (steps, tools, etc.)
- Installation quality control
- Structural and module installation
- Electrical installation
- Driving of pile

## After-sales

### After-sales service

- Customer response within 24 hours
- Providing after-sales solutions within 15 days
- Immediate remote guidance for system commissioning
- Visualized after-sales service process
- Performance validation to ensure stable and efficient operation
- Assistance in purchasing spare parts, installation and commissioning
- SCADA monitoring and O&M recommendations for high efficiency

## Engineering

### Detailed engineering design

- Layout optimization
- Complete construction drawings
- Technical FAQ

## Commissioning

### Commissioning

- Material checklist and preparation
- Deficiency elimination
- Remote commissioning, data monitoring
- Training and on-site guidance

### Service center

- China: Changzhou, Shanghai
- Europe: Madrid, Spain
- Australia: Melbourne
- USA: Albuquerque
- South America: Brazil, Chile



# 03

## Case Study

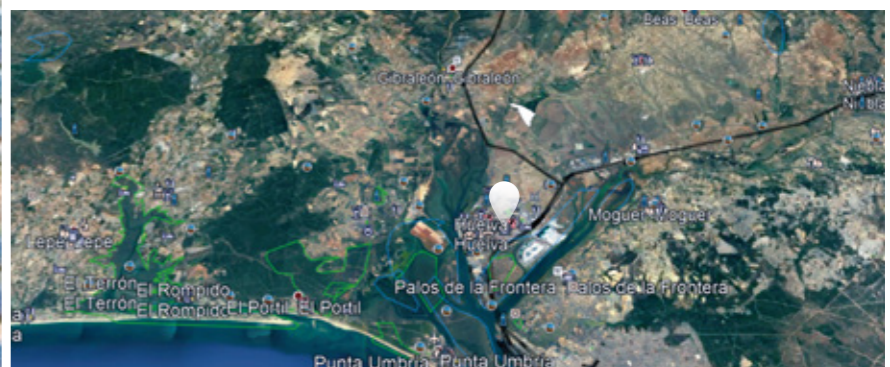

# 50 MW

## Huelva, Spain

•Site / Huelva, Spain  
 •Capacity / 50MW  
 •Owner / GES

Tracker type / SP240(Agile series)  
 Module / LONGi LR4-72HBD 425-455M

### Project Information

The Huelva 2021 Solar Power Plant is a park with an installed capacity of 50MW. Two specs of SP240 trackers (predecessor of Agile 1P), namely 1Px56 and 1Px28, were installed to suit the needs of different terrains. More than one hundred thousand PV panels were installed in the park, with an annual capacity of 100 GWh, equivalent to the consumption of 28,000 households in Spain.

### Site Description

(Provincia de Huelva) is a province of southern Spain, in the western part of the autonomous community of Andalusia. It is bordered by Portugal. Huelva is known as the sunniest city in Spain. Thanks to the excellent light conditions, the city has become a hot spot for investment in PV plant. But Huelva was not an ideal location for the operators in terms of preliminary foundation construction. According to the investigation, although located in the coastal area, Huelva is close to the mountains, while rivers are densely distributed, resulting in complicated geological conditions with slopes.

### Project Challenge

Huelva is the first project to use the Agile series trackers. One of the challenges encountered by the operators during the engineering phase was that the slope of the trackers should be increased to 8% to meet the technical specifications for ground slopes higher than the maximum design slope (5%). On the other hand, due to the geotechnical characteristics of the project area, longer piles were required to ensure the stability of the tracker foundation.

### TrinaTracker Solution

To avoid additional earthworks by the client, TrinaTracker's staff repeatedly reviewed and modified the project to enhance the properties of some mechanical parts of the trackers. In addition to product supply, TrinaTracker made a great effort to offer professional service during the delivery process, sending a technical team on site for installation guidance and tracker commissioning. This ensured timely commissioning and successful operation of the systems.

### Owner Testimonials

"We're quite impressed by the professional service offered by TrinaTracker all the way from delivery to on-site installation, and the reliability of product itself. We look forward to working with TrinaTracker again for the upcoming projects," explained Mr. José Luis Morlanes Galindo, CEO of Alter Enersun that owns the Huelva project. For the solar power plant, solar trackers provided by TrinaTracker have proven to run at high efficiency since its commissioning in summer 2021. No complaints have been received since the start of construction, fully proving the outstanding quality of the Agile series trackers.



# 400MW Nangong, Hebei Province

**Site** / Nangong, Xingtai, Hebei Province    **Tracker type** / Vanguard-2P  
**Installed capacity** / 400MW    **Module** / Vertex 550W  
**Owner** / Guosun New Energy  
**Contractor** / PowerChina Jiangxi Electric Power Construction Co., Ltd.  
**COD** / 2020.12



## Project Information

On December 30, 2020, the GuoShun 400MW PV agricultural project was successfully connect to the grid. The project is equipped with TrinaTracker Vanguard-2P trackers and 210mm Vertex modules. The successful grid connection of the Nangong project once again proved that TrinaTracker is the only company in the industry that can supply the package of “modules + trackers”.

## Site Description

Nangong is one of the 19 counties/county-level cities/districts under the jurisdiction of Xingtai, Hebei Province. The county-level city is named after Nangong, one of the eight sages of the Western Zhou Dynasty. Known as the revolutionary base in Southern Hebei Province, Nangong is located in the southern part of the Hebei Plain with flat terrain. The famous Battle of Julu in ancient China took place nearby. Nangong is renowned for its animal husbandry and agriculture. It has been awarded the titles of “National High Quality Cotton Production Base”, “Shorn Sheepskin Capital of China”, etc. The Nangong project is located in more than 40 unincorporated villages. From the air, you can see numerous modules and trackers are dotted all over Nangong, like sapphire inlaid in the golden earth, which are truly breathtaking.

## TrinaTracker's Advantages

The Nangong project uses Vanguard-2P for the first time in China. Compared with 1P trackers, 2P trackers need to accommodate more PV panels in a limited land area. Therefore, they should have higher bearing capacity and better wind resistance with a more complex structure. Therefore, a multi-drive system is innovatively used in Vanguard-2P to deal with structural failures. Patented spherical bearings reduce additional stress and the rate of component failures caused by system deformation. The self-developed controller and the Smart Tracking Algorithm can monitor wind speed in real time and adjust the best wind resistance angle to maximize the protection of trackers and modules from strong winds.

## Measured Data

In terms of irradiance, previous data show that, with the common solution, the number of hours when light is effectively utilized in three years is less than 1,250h on average. Thanks to the adoption of Trina's bifacial modules, the number of hours when light is effectively utilized in three years can be increased to no less than 1,350h. TrinaTracker's intelligent algorithm further optimizes the power generation efficiency of bifacial modules, improving it by 9% on the original basis. The number of hours when light is effectively utilized in three years can reach about 1,480h, significantly improving the owner's earnings.





# 25MW Taung Daw Gwin Myanmar

**Site** / Kyaukse, Myanmar  
**Capacity** / 25MW  
**Owner** / China Construction Machinery  
**Tracker type** / Vanguard-1P  
**Module** / Trina TSM-DEG19C.20



## Project Information

Myanmar is an agricultural country with an underdeveloped industry. Kyaukse City in Myanmar suffers from severe power shortages, with power outages once an hour on average every day. The estimated power output of the photovoltaic power station is 45,000,000 kwh, accounting for 14% of the annual local electricity consumption; 120,000kwh is generated during the day, accounting for 29% of the electricity consumption during the day, which greatly alleviates the difficulty of local electricity use.

## Site Description

The Taung Daw Gwin project site is located in the mountains of central Myanmar and has a tropical monsoon climate with abundant rainfall. The central region is prone to rainfall in August and September, and Myanmar is one of the 10 countries that are worst affected by climate change from 1990 to 2008. Over the past 18 years, cyclones and floods have brought huge losses to Myanmar. The ground clearance and wind resistance conditions should be considered for the construction of the power station.

## Project Challenge

This project is the second photovoltaic project of the Burmese owner. The first 30MW project adopts the products of another Chinese manufacturer, and many control boxes of this manufacturer have burnt out or become uncontrollable. Therefore, the owner inquired many times from delivery to installation to commissioning and had doubts about the pass rate of the control box. The workers hired by the project are basically local villagers who live on farming and are unfamiliar with the mounting brackets and even the types of bolts and nuts, so there is some difficulty in installation. Myanmar is prone to floods and cyclones, and the brackets need to cope with extreme weather.

## TrinaTracker Solution

We emphatically introduced the advantages of TrinaTracker TCU during the technical guidance, and during the commissioning process, we introduced the use of the software to the customer's technicians, and answered some questions left by the customer about the control box.

During the installation process, we made detailed technical disclosures to the owner's technicians, and arranged special workers to pre-assemble each component in the material warehouse, reducing the work complexity of bulk materials on site, so that the installation could be completed smoothly.

## Owner Testimonials

TrinaTracker provided the customer with one-stop system integration solutions covering design, construction, operation and maintenance. In the ending stage of the project, the customer sent a letter of appreciation to praise TrinaTracker for communication and coordination, installation guidance, scheduling, epidemic prevention, and safety management on the site. The customer was deeply impressed by the professional quality of our staff, and sincerely hoped to cooperate with TrinaTracker and create brilliant future together with TrinaTracker in the future.





# 505<sub>MW</sub>

## Gonghe County, Qinghai Province, China

Site / Gonghe County, Qinghai Province

Installed capacity / 505MW Phase I + Phase II

Owner / Huanghe Hydropower

COD / 2020.06

Tracker type / Vanguard-1P

Module / Trina, JinkoSolar, JA, etc. 500W





# 100<sub>MW</sub>

## Xinjiang Province, China

Site / Jimusar County    Installed capacity / 100MW    Tracker type / Vanguard-1P    Module / Trina Vertex 670W







# 519.4MW

## Paraíba, Brazil

Site / Santa Luzia    Installed capacity / 519.4MW    Tracker type / Vanguard-1P    Module / Jinko Tiger







# 10.8MW

## Chile

Site / Rimini

Installed capacity: / 10.8MW

Tracker type: / Vanguard-1P







# 57 MW

## Córdoba, Spain

Site / Jumilla

Installed capacity / 57MW

Tracker type / Vanguard-1P







# 11.32<sub>MW</sub>

## Córdoba, Spain

Site / Campiña Installed capacity / 11.32MW

Tracker type / Vanguard-1P